

directional signage
signalétique directionnel
sinalética direcional

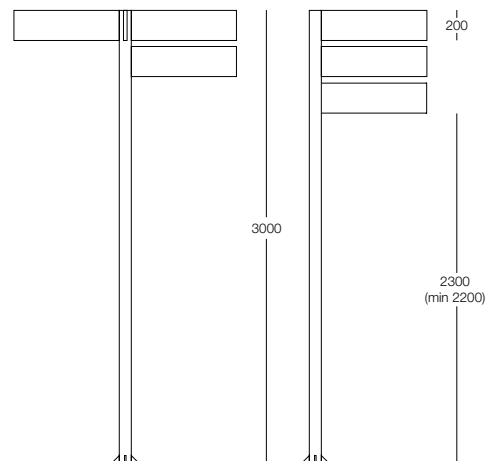

4 directions on the same plane
4 directions sur le même plan
4 direções no mesmo plano

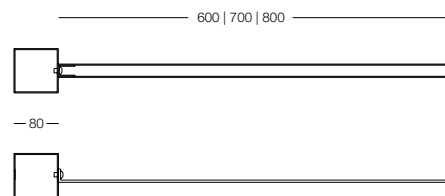

EN Pole: steel
Plates: steel
Information: cut vinyl
Fixing: [LF1] Refer to technical section

FR Poteau: acier
Plaque: acier
Information: vinyle découpé
Fixation: [LF1] Consulter section technique

PT Poste: aço
Placa: aço
Informação: vinil autocolante recortado
Fixação: [LF1] Consultar secção técnica

Standard:
Enamel forge Q808
Ral 9010 (plates)
Metallization (pole)
Zincod (plates)

Émail forge Q808
Ral 9010 (plaques)
Métallisation (poteau)
Zingué (plaques)

Esmalte forja Q808
Ral 9010 (placas)
Metalização (poste)
Zincagem (placas)

QUADRIS

signage | signalétique | sinalética
design **Larus**

EN Signage system with a simple, economical and easy maintenance conception. Square tubes used as poles.

FR Système de signalétique avec une conception simple, économique et d'entretien facile. Utilisation de tubes carrés comme poteaux.

PT Sistema de sinalética com uma conceção simples, económica e de fácil manutenção. Utilização de prumos quadrados.

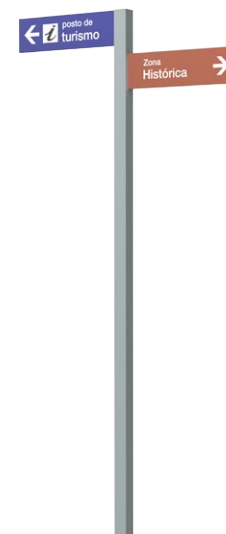

**TECHNICAL SECTION
SECTION TECHNIQUE
SECÇÃO TÉCNICA**

FIXING SYSTEM REFERENCES . TOLERANCES FOR LINEAR DIMENSIONS
STEEL/STAINLESS STEEL . CAST IRON . METALLIZATION . GALVANIZATION . SOLAR BEAN
BEWARM TECHNOLOGY .WOOD . CRACKS AND WARPING IN WOOD
PROTECTIVE VARNISH/LASUR IN WOOD . PAINT . ELECTRICITY . ROTOMOLDING

RÉFÉRENCES DES SYSTÈMES DE FIXATION . TOLÉRANCES POUR DIMENSIONS LINÉAIRES
ACIER/ACIER INOX . FONTE . MÉTALLIZATION . GALVANISATION . LATTE SOLAIRE
TECHNOLOGIE BEWARM . BOIS . FENTES ET GAUCHISSEMENTS (BOIS)
VERNIS/LASURE PROTECTEUR (BOIS) . PEINTURE . ELECTRICITÉ . ROTOMOULAGE

REFERÊNCIAS DE SISTEMAS DE FIXAÇÃO . TOLERÂNCIAS PARA DIMENSÕES LINEARES
AÇO/AÇO INOX . FERRO FUNDIDO . METALIZAÇÃO . GALVANIZAÇÃO . RÉGUA SOLAR
TECNOLOGIA BEWARM . MADEIRA . FENDAS E EMPENOS NA MADEIRA
VERNIZ PROTECTOR NA MADEIRA . PINTURA . ELECTRICIDADE . ROTOMOLDAGEM

Fixing system references

Références des systèmes de fixation

Referências de sistemas de fixação

LF1

rods anchored on the floor/concrete foundation with chemical anchor

tiges ancré au sol/fondation en béton avec chevilles chimiques

varões chumbados no pavimento/ fundação de betão com bucha química

LF2

anchorage previously attached to the concrete foundation

ancré précédemment fixé sur la fondation en béton

chumbadouro previamente chumbado na fundação de betão

LF3

anchored directly on the concrete foundation

ancré directement sur la fondation en béton

chumbada diretamente na fundação de betão

LF4

bolted to the frame previously anchored on the concrete

boulonné à la jante précédemment ancré au béton

aparafusada ao aro previamente chumbado no betão

LF5

foundation on wooden beams previously attached to the structure

fondation sur des poutres en bois précédemment fixé à la structure

fundação em vigas de madeira previamente fixa à estrutura

LF6

floorstanding

appuyé sur le sol

pousado sobre o solo

Fixing accessories are not included in the price list, being supplied on request, according to local conditions.

Les accessoires de fixation ne sont pas inclus dans la liste de prix, étant fournis sur demande, selon les conditions locales.

Os acessórios de fixação não estão considerados no preço, sendo fornecidos sob consulta, de acordo com as condições locais.

Tolerances for linear dimensions

Tolérances pour dimensions linéaires

Tolerâncias para dimensões lineares

dimensions | dimensions | dimensões

deviations | déviations | desvios - mm

0 - 100	> 100 - 500	> 500 - 2000	> 2000 - 3000	> 3000 - 5000	> 5000
---------	-------------	--------------	---------------	---------------	--------

tolerances | tolérances | tolerâncias

± 1	± 2	± 3	± 4	± 5	± 10
---------	---------	---------	---------	---------	----------

The tolerances in the technical drawings shall prevail over the tolerances in this table.

Les tolérances indiquées dans les dessins techniques doivent prévaloir sur les tolérances indiquées dans ce tableau.

As tolerâncias que constam nos desenhos técnicos prevalecem sobre as tolerâncias desta tabela.

Our products admit dimensional tolerances. For precise dimensions, request for cad-2d drawings.

Nos produits admettent des tolérances dimensionnelles. Pour des dimensions précises, demandez des dessins cad-2d.

Os nossos produtos admitem tolerâncias dimensionais. Para dimensões precisas, solicitar desenhos cad-2d.

Steel / Stainless Steel

Acier / Acier Inox

Aço / Aço inox

EN **Steel** (EN10025) is an alloy combining iron and carbon, with a maximum carbon content of approx. 2.1%. With **low carbon content (<0.3%)**, has a high ductility and good characteristics for the mechanical work and welding. **Stainless steel**, contain at least 11% of chromium, ensuring a high resistance against corrosion, forming a thin adhesive film, which protects the material from corrosive attacks in contact with water or moist air (AISI 304). With the appropriate additions of chromium, nickel and molybdenum, it is possible to obtain alloys particularly suited to be used in saline or acidic environments (AISI 316).

Corten steel forms a stable rust-like appearance and incorporates high levels of cooper. The iron oxide and copper resulting from oxidation, form an “aged” layer that prevents the progression of oxidation.

FR L'**acier** (EN10025) est un alliage de fer-carbone, avec une teneur maximale en carbone d’environ 2,1%.

À **basse teneur en carbone (<0,3%)**, possède une grande ductilité et de bonnes caractéristiques pour le travail mécanique et la soudure. L'**acier inoxydable**, contiennent au minimum 11% de chrome, garantissant une haute résistance à la corrosion, en formant une fine pellicule adhérente et passive qui protège le matériel des attaques corrosives en contact avec l'eau ou avec l'air humide (AISI 304). Avec les additions appropriées de chrome, de nickel et de molybdène, on réussit des alliages particulièrement adaptés à l'utilisation en milieux salins ou acides (AISI 316). L'**Acier Corten** a une apparence de rouille, stable, et intègre niveaux élevés de cuivre. L'oxyde de fer et de cuivre résultant de l'oxydation, forment un couche “âgée” que empêche la progression de l'oxydation.

PT O **aço** (EN10025) é uma liga de ferro-carbono, com um teor máximo em carbono de 2,1%. Com **teor em carbono <0,3%** possui grande ductilidade e boas características para o trabalho mecânico e soldadura. O **aço inoxidável** contém no mínimo 11% de cromo, garantindo elevada resistência à corrosão, protegendo o material de ataques corrosivos em contacto com a humidade (AISI 304). Com as adequadas adições de cromo, níquel e molibdénio, conseguem-se ligas adaptadas à utilização em meios salinos ou ácidos (AISI 316). O **aço corten** incorpora teores elevados de cobre. O óxido de ferro e cobre decorrente da oxidação, forma uma camada “envelhecida” e que impede a progressão da oxidação.

Corten steel aging process



Day 1



2 Months

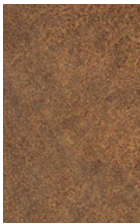

5 Months



Cast Iron

Fonte

Ferro fundido

EN Cast iron is a ferrous alloy with a carbon content higher than 2%. In **lamellar gray cast iron**, graphite surface solidifies in the form of flakes, result of high levels of carbon and silicon and of slow cooling. This alloy has high capacity for vibration damping, high aptitude for machining, (carbon in the form of graphite as lubricant), good corrosion resistance (greater than carbon steel) and a reduced contraction associated with good fluidity that facilitates the casting of complex parts. **Nodular (spheroidal) cast iron** is obtained with the introduction of alloying elements (inoculants) within the liquid bath treatment. The graphite precipitates as nodules or spheres, improving its mechanical properties, which approaches it to steel in ductility and tensile strength.

FR Alliage ferreux avec une teneur en carbone supérieure à 2%. Dans la **fonte grise lamellaire** graphite se solidifie sous la forme de flocons, conséquence des hautes teneurs en carbone et en silice et du refroidissement lentes. Présente une capacité élevée d’amortissement de vibrations, une grande aptitude à l’usinage (c arbone sous forme de graphite comment lubrifiante) , une bonne résistance à la corrosion dans différentes ambiances communes (supérieure aux aciers au carbone) et une faible rétraction, associée à une bonne fluidité, ce qui facilite la fonderie de pièces complexes . La **fonte nodulaire (sphéroïdale)** est obtenue par l’introduction d’éléments inoculants dans le bain liquide. Le graphite est précipité comme nodules ou de sphères, en améliorant les caractéristiques mécaniques, en se rapprochant des aciers en termes de ductilité et de résistance à la traction.

PT Liga ferrosa com teor em carbono superior a 2%. No **ferro fundido lamelar** a grafite solidifica sob a forma de flocos, consequência de altos teores de carbono e silício e de arrefecimento lento. Tem elevada capacidade de amortecimento de vibrações, grande aptidão à maquinagem (carbono sob a forma de grafite como lubrificante), boa resistência à corrosão (superior aos aços ao carbono) e reduzida contracção, associada a uma boa fluidez, facilitando a fundição de peças complexas. O **ferro fundido nodular (esferoidal)** obtém-se pela introdução de inoculantes no banho líquido. A grafite precipita como nódulos ou esferas, melhorando as características mecânicas, aproximando-se dos aços em ductilidade e resistência à tracção.

lamellar

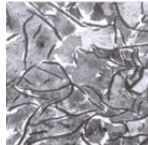

nodular

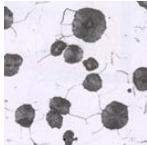

Metallization Métallization Metalização

EN Protection of a surface, by projecting zinc or a zinc/ aluminum alloy, with degreasing and deoxidation through an abrasive jet of shot blasting. The thickness of the zinc layer reached has a minimum thickness of 30-40 microns.

Advantages of painting on metallization:

- It is an ideal surface for subsequent application of painting
- Long lasting protection against corrosion, with an excellent abrasion resistance, which limits the frequency and cost of the maintenance, by adjusting the thickness of the coating, depending on the aggressiveness of the environment.
- No change of the mechanical properties.

Disadvantages of painting on metallization:

- The interior areas of pieces are not protected.

FR Protection de surface qui consiste en la projection de zinc ou de l'alliage zinc/aluminium, avec dégraissage et désoxydation par un jet abrasif de grenailage. L'épaisseur de la couche de zinc obtenue a un minimum de 30-40 microns.

Avantages de la peinture sur métallisation:

- Constitue une surface idéale pour une application postérieure de peintures
- Protection anti-corrosive de longue durée, avec une excellente résistance à l'abrasion, qui limite la fréquence et le coût des entretiens en adaptant l'épaisseur du revêtement en fonction de l'agressivité du milieu.
- Aucun changement des propriétés mécaniques.

Inconvénients de la peinture sur métallisation:

- Les aires internes des pièces ne sont pas protégées.

PT Protecção de superfície projectando zinco ou zinco/ alumínio, com desoxidação e desengorduramento com jacto abrasivo por granalha, atingindo o depósito de zinco uma espessura mínima de 30-40 microns.

Vantagens da pintura sobre metalização

- A rugosidade da superfície favorece a aderência da pintura.
- Protecção anticorrosiva de longa duração, com excelente resistência à abrasão, limitando a manutenção, adaptando a espessura do revestimento em função da agressividade do meio ambiente.
- Sem alteração das propriedades mecânicas.

Inconvenientes da pintura sobre metalização

- As áreas interiores das peças não são protegidas.

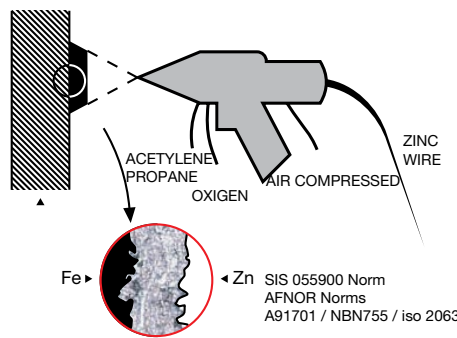

Galvanization Galvanisation Galvanização

EN Protection of the surface, obtained by the immersion in a bath of zinc (min 98% of pure zinc) at about 450 °C. The zinc metallurgically reacts with the metal surface of the piece. The thickness of the zinc layer obtained is of at least 60 microns.

Advantages:

- The immersion allows to coat hollow pieces.
- The thickness of the coating ensures the protection of edges and corners.

Disadvantages:

- The surface may present runoff of the bath.
- Greater difficulty in paint adhesion, requiring sanding or phosphating.
- Not suitable for cast iron, due to silicon and phosphorus contents exceeding 0.004% and 0.02%, respectively.

FR Protection de surface, obtenue par immersion dans un bain de zinc (min 98% Zinc pur) à environ 450°C. Le zinc réagit métallurgiquement avec la surface métallique de la pièce, en formant un alliage de zinc/fer. L'épaisseur de la couche de zinc obtenue est, au minimum, de 60 microns.

Avantages:

- l'immersion permet de revêtir des pièces creuses.
- L'épaisseur du revêtement assure la protection des bords et des coins.

Inconvénients:

- La surface peut présenter un ruissellement du bain de zinc.
- Une plus grande difficulté à adhérence de la peinture, ce qui nécessite un ponçage ou phosphatage.
- Non adapté à la fonte, en raison de teneurs en silicium et en phosphore supérieures à 0,004 % et 0,02 % respectivement.

PT Protecção de superfície por imersão em banho de zinco (mín 98% Zinco) a cerca de 450°C. Reagindo com a superfície metálica forma uma liga de Zinco/Ferro. Espessura de zinco mínimo de 60 microns.

Vantagens:

- A imersão permite revestir peças ocas.
- A espessura do revestimento garante a protecção de arestas e esquinas.

Inconvenientes:

- Podem existir escorrimientos do banho.
- Para a adesão da pintura, é necessário lixar a superfície ou usar fosfatação.
- Não adequado ao ferro fundido, por ter teores em silício e fósforo superiores a 0,004% e 0,02%, respetivamente.

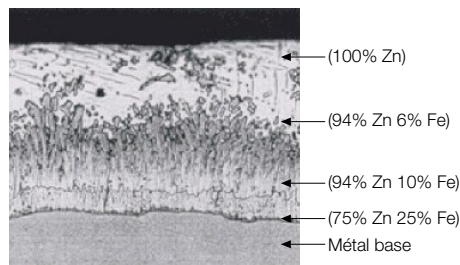

Solar bean Latte solaire Régua solar

EN Focused on sustainability, clean energy and aligned with the technological principles of smart cities, Larus has developed the LARUS SOLAR range. Integrated into tables and benches, this solution produces and stores 100% green solar energy, promoting urban connectivity and consumer technology trends.

Standard features

Wireless charging, LED lights (3000K), connectivity with Data plan (SIM card included),k, GPS location, coolers (from 30° C), user counter (number of charges).

Add-on options

USB charging (A+C - one entry each), air quality sensors, additional battery (2x superior), increase energy output, WiFi (independent ruler).

FR Engagée en faveur du développement durable et des énergies propres, et parfaitement alignée avec les principes technologiques des smart cities, Larus a conçu la gamme innovante LARUS SOLAR. Intégrée dans des bancs et des tables urbaines, cette solution intelligente génère et stocke une énergie solaire 100 % verte, tout en favorisant la connectivité urbaine et les nouvelles tendances technologiques.

Fonctionnalités standards

Recharge sans fil par induction, éclairage LED (3000K), connectivité avec forfait de données (carte SIM incluse), système de géolocalisation GPS, système de refroidissement intelligent (activé à partir de 30°C), compteur d'utilisateurs (nombre de recharges).

Options supplémentaires

Ports de recharge USB (type A+C), capteurs de qualité de l'air, batterie supplémentaire (capacité doublée, puissance de sortie accrue, connexion Wi-Fi indépendante).

PT Focada na sustentabilidade, nas energias limpas e alinhada com os princípios tecnológicos das smartcities, a Larus desenvolveu a gama LARUS SOLAR. Integrada em mesas e bancos, esta solução produz e armazena energia solar 100% verde, promovendo a conectividade urbana e as tendências tecnológicas de consumo.

Funcionalidades standard

Carregamento por indução, luzes LED (3000K), conectividade c/ plano de dados (cartão SIM incluído), localização GPS, refrigeradores (a partir dos 30° C), contagem de utilizadores (n° de carregamentos).

Funcionalidades adicionais

Carregamento USB (A+C - uma entrada de cada), sensores de medição da qualidade do ar, bateria adicional (2x superior), aumento da saída de energia, WiFi (régua independente).



BEWARM technology Technologie BEWARM Tecnologia BEWARM

EN Intelligent heating systems, fully integrated into concrete structures, designed to provide thermal comfort in an efficient and intelligent way.

Composed of a sensorized heating system with temperature control units, coupled to concrete with different layers (conductive, insulating) that are optimized for efficient heat storage and dissipation.

With high thermal efficiency, allowing rapid heating, maintaining the temperature for long periods, even after the system is switched off, taking advantage of the thermal inertia of the concrete.

FR Systèmes de chauffage intelligents, entièrement intégrés dans des structures en béton, conçus pour offrir un confort thermique efficace et intelligente.

Composé d'un système de chauffage déjà équipé de capteurs et de dispositifs de contrôle de température, couplé à des bétons avec différentes couches (conductrices, isolantes) optimisées pour un stockage et une dissipation thermique efficaces, ils offrent un rendement thermique élevé, permettant un chauffage rapide et un maintien de la température pendant de longues périodes, même après l'arrêt du système, grâce à l'inertie thermique du béton.

PT Sistemas de aquecimento inteligentes, totalmente integrados em estruturas de betão, concebidos para proporcionar conforto térmico de forma eficiente, inteligente.

Composto por um sistema de aquecimento já sensorizado e com unidades de controlo de temperatura, acoplado a betões com diferentes camadas (condutoras, isolantes) que estão otimizadas para o armazenamento e dissipação eficiente do calor.

Com alta eficiência térmica, permitindo o rápido aquecimento, mantendo a temperatura por longos períodos, mesmo após o sistema se encontrar desligado, tirando partido da inércia térmica do betão.

Wood Bois Madeira

EN Wood is one of the most important building materials and requires an energy consumption for its production (5 to 7.5 KWH / Ton) much lower than other materials (concrete 25 to 300; glass 6000, plastic 8200 to 20.000, aluminum 72.000).

It is also the only renewable building material and neutral regarding the CO2 emission.

Inconvenients:

- In contact with ground water, or soaked, may be attacked by fungi;
- In environments of low oxygen content, may be attacked by bacteria;
- Used outdoors, it is susceptible of having cracks caused by the absorption of water;
- Subject to the action of UV rays, lignin, a component of the wood, rots.

For each use it is necessary to apply the woods with the most recommended features, as well as to employ preserving treatments. After slaughter, the water content (initially above 40%) decreases. Free water evaporates, until reaching the saturation point of the fibers. Here, the remaining water is retained in the cell walls and its content is around 30%.

If the wood dries below the saturation point of the fiber, it shrinks, but it swells again if it is moistened.

- The tangential contraction is about twice the radial contraction;
- The axial (length of the torus) contraction is very low. The wood should be dried out before use (until the characteristic content moisture of the application area).

FR Le bois est l'un des matériaux de construction les plus importants et qui exige une consommation d'énergie pour sa production (5 a 7,5 KWH/Ton) très inférieure aux autres matériaux (béton 25 a 300; verre 6.000; plastique 8.200 a 20.000; aluminium 72.000). C'est aussi le seul matériau de construction renouvelable et neutre quant à l'émission de CO2.

Inconvénients:

- En contact avec l'eau du sol, ou en immersion, peut être attaqué par des champignons;
- Dans des milieux a basse teneur en oxygène, peut être attaqué par des bactéries;
- Utilisé à l'extérieur, il est susceptible de subir des fentes causées par l'absorption de l'eau;
- Soumis à l'action des rayons UV, la lignine, un des composants du bois, pourrit.

Pour chaque utilisation, il faut employer les bois possédant les caractéristiques conseillées, et faire également appel à des traitements de préservation. Après abattage, la teneur en eau (initialement supérieure à 40%), diminue. L'eau libre s'évapore, jusqu'à atteindre le point de saturation des fibres. L'eau restante se maintient dans les parois des cellules, en tournant autour de 30%.

Si le bois sèche au-dessous du point de saturation des fibres, il rétrécit, mais gonfle à nouveau s'il est humidifié.

- La rétraction tangentielle correspond à près de deux fois la rétraction radiale;
- La rétraction axiale (longueur du tronc) est très faible. Il faut sécher le bois avant qu'il soit utilisé, jusqu'à la teneur en humidité caractéristique de l'aire d'application.

PT A madeira é um dos mais importantes materiais de construção e exige menor consumo de energia (5 a 7,5 KWH/Ton) para a sua produção que outros materiais (betão 25 a 300; vidro 200; plástico 8,2 a 20 e alumínio 72). É o único material de construção renovável e neutro quanto à emissão de CO2.

Inconvenientes:

- Em contacto com a água do solo, ou em imersão, pode ser atacada por fungos;
- Em ambientes de reduzido teor de oxigénio, pode ser atacada por bactéria;
- No exterior sofre fendas e empenos, causados pela absorção da água;
- Sujeita à acção dos raios UV, a lenhina, um dos componentes, apodrece.

Para cada utilização é necessário empregar as madeiras com as características mais aconselhadas, bem como recorrer a tratamentos de preservação. Após o abate, o teor em água (inicialmente superior a 40%) diminui. A água livre evapora-se até atingir o ponto de saturação das fibras. A água restante mantém-se nas paredes das células, rondando os 30%. A madeira encolhe se secar abaixo do ponto de saturação das fibras, mas incha novamente se for humedecida.

- A contracção tangencial da madeira é cerca de duas vezes a contracção radial;
- A contracção axial (comprimento) é muito reduzida. Antes de ser usada, deve secar-se a madeira, próximo ao teor de humidade característico da área de aplicação.

Cracks and warping in wood Fentes et Gauchissements (bois) Fendas e Empenos na madeira

EN When hitting one side of the timber, the sun and wind remove the surface water. The water in the interior will come to the surface at a speed slower than its removal from the surface. The peripheral layers (more dry) shrink more than the inner layers (more humid), creating internal tensions that are relieved with the opening of cracks that soften when the external humidity increases. In the case of a board, warping is caused by the contraction of the dried layers, contrary to the opposite side, that doesn't contract in the same way and is unable to completely counteract this effort. Therefore the use of wide boards should be avoided. The wood cracks the most the lower its density is, because there are more empty spaces between the cells occupied by air.

FR Le soleil et le vent, qui ont une incidence sur le bois, en retirent l'eau superficielle. L'eau existante à l'intérieur migre vers la surface, à une vitesse plus lente que celle qui est retirée de la surface. Les couches périphériques, plus sèches, se rétractent davantage que les couches intérieures, en générant des tensions internes qui sont soulagées par l'ouverture de fentes qui, lorsque l'humidité extérieure augmente, s'atténuent à nouveau. Dans le cas d'une planche, le gauchissement est provoqué par la rétraction des couches sèches, contrairement au côté opposé, qui ne s'est pas rétracté de la même manière et qui n'a pas la capacité de contrarier complètement cet effort. Il faut donc éviter l'utilisation de planches très larges. Plus petite est leur intensité, plus les bois se fendent, car ils ont plus d'espaces vides entre les cellules occupées par l'air.

PT O sol e o vento, ao incidirem sobre a madeira, removem a água superficial. A água no interior migra para a superfície, a uma velocidade inferior à que é removida. As camadas periféricas, mais secas, retraem-se mais que as camadas interiores, gerando tensões internas, aliviadas com a abertura de fendas que, quando a humidade exterior aumenta, se atenuam novamente. Numa tábuca o empeno é provocado pela contracção das camadas secadas, em oposição à face oposta, que não contraiu nem consegue contrariar este esforço. Deve evitar-se a utilização de tábuas muito largas. As madeiras fendilham tanto mais quanto menor for a sua densidade, pois têm mais espaços vazios entre as células.



Protective varnish/lasur in wood Vernis/lasure protecteur (bois) Verniz protector na madeira

EN The action of the U.V. rays causes the degradation of lignin, favoring its decay. Varnish iron oxides work as parallel lamellae to timber surface, promoting the reflection of the U.V. rays. The greater the number of varnish applications, the greater the UV protection would be. However, it darkens the color of the wood. Varnish is non-toxic, aqueous solvent, particularly suitable for the use of children. Immersion of a wood filler promotes the adhesion of resin to wood, preceded by a minimum of two varnish coats. For maintenance, wooden slats must be individually sanded, cleaning the layer that contains decomposed lignin. Apply at least two coats of non-toxic varnish within 18 month intervals. This time period should be reduced with the increasing aggressiveness of the environment. With a greater number of varnish coats, we enlarge the time period between maintenance.

FR Les rayons UV cause la dégradation de la lignine en favorisant son pourrisage. Les oxydes de fer des vernis fonctionnant comme des lamelles parallèles à la surface du bois, favorisent la réflexion des rayons UV. Plus il y aura d'applications de vernis et plus le bois sera protégé contre les UV. Toutefois, la couleur du bois devient plus foncée.

Le vernis est non toxique, à solvant aqueux, adapté à l'utilisation par des enfants. Une substance d'imprégnation favorise l'adhérence de la résine au bois, suivie d'un minimum de 2 couches de vernis. Pour l'entretien il faut poncer les lattes individuellement, nettoyées de la couche qui contient la lignine décomposée. Appliquer, au minimum, 2 couches de vernis tous les 1,5 ans. Il faut réduire ce délai, avec l'augmentation de l'agressivité du milieu. Avec un plus grand nombre de couches de vernis, nous prolongeons la durée entre les entretiens.

PT Os raios U.V. degradam a lenhina, originado o apodrecimento superficial. Os óxidos de ferro dos vernizes constituem lamelas paralelas à superfície da madeira, provocando a reflexão dos raios U.V. Excessiva aplicação favorece a protecção aos UV, mas escurece a madeira. O verniz utilizado é não tóxico, aquoso, adequado à utilização por crianças. Um impregnante favorece a aderência da resina, antes de 2 demãos de verniz. Para a manutenção devem lixar-se as réguas individualmente, limpas da camada da lenhina decomposta. Aplicar 2 demãos de verniz de 1,5 em 1,5 anos. Deve reduzir-se este prazo com o aumento da agressividade do ambiente. Com maior número de demãos de verniz, amplia-se o tempo entre manutenções.

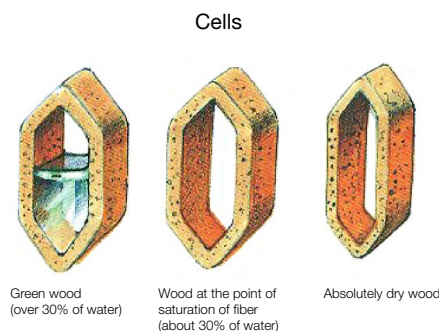

Contraction by drying

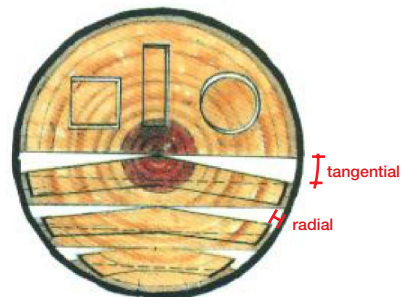

Paint Peinture Pintura

EN **Enamel Forge** - On the primer a metal enamel is applied with high anticorrosive power and weather resistance. It has the appearance of wrought iron.

Epoxy - iron oxide paint, with higher durability, hardness and resistance.

Synthetic Enamel - Bright, used for the painting of steel structures. Has good gloss retention.

Polyurethane Enamel - With high brightness, is used for painting of metal and wooden structures. It has high gloss retention and risk resistance. It has an excellent adhesion to iron and wood and highly resistant in corrosive environments.

Electrostatic powder coating - Uniform coating with excellent finishing. Excellent adhesion characteristics, abrasion resistance and chemical resistance. It contains no solvents; doesn't emit volatile organic compounds (VOCs) into the atmosphere.

FR **Émail Forge** - On applique, sur le primaire, un émail métallique, anti-corrosif et résistant aux intempéries. Aspect de fer forgé.

Épóxi - peinture d'oxyde de fer, durable, dur et résistant.

Émail synthétique - Brillant, destiné à la peinture de structures métalliques. Possède une bonne rétention de brillance.

Émail de polyuréthane - Haute brillance, destinée à la peinture de substrats métalliques et de bois. Possède haute rétention de brillance et une résistance aux rayures. Excellente adhérence au fer et au bois. Haute résistance aux milieux corrosifs.

Électrostatique Poudre - Revêtement uniforme avec une excellente finition. Excellentes caractéristiques d'adhésion, de résistance à l'abrasion et une résistance chimique. Ne contient pas de solvants, et n'émet pas de composés organiques volatils (COV) dans l'atmosphère.

PT **Esmalte Forja** - Sobre o primário é aplicado esmalte metálico anticorrosivo e resistente, com o aspecto de ferro forjado.

Epóxi - tinta com óxido de ferro, durável, dura e resistente.

Esmalte sintético - Brilhante, destinado à pintura de estruturas metálicas. Possui boa retenção do brilho.

Esmalte de poliuretano - Com alto brilho, destinado à pintura de superfícies metálicas e de madeira. Elevada retenção de brilho e resistência ao risco. Boa aderência ao ferro e à madeira. Boa resistência em ambientes corrosivos.

Tinta Electrostática a Pó - Revestimento uniforme com bom acabamento. Boas características de adesão, resistência à abrasão e resistência química. Não contém solventes, não emitindo compostos orgânicos voláteis (COV) para a atmosfera.



Electricity Électricité Electricidade

EN **Kiosks and Terraces Protection of People**
Protection against electric shock and electrical contacts is ensured (RTIEBT). Usage of TT system (neutral earthed and earthed mass), for protection against electric shock with the implementation of security measures.

Direct contacts: isolation of the active parts with enclosure IP code equal or superior than IP2X. In addition, high sensitivity differential devices are installed (I n<30mA).

Indirect contacts: differentials are used according to the circuit to be protected conditions (humidity, type of users). Equalization of metal mass powers accessible simultaneously is assured (kitchens).

Facility Security
Protection against overloads and short circuits is assured through the installation of Thermal-Magnetic Breakers at the origin of the circuits.

FR **Kiosques et Terrasses Protection des personnes**
Protection contre les chocs et les contacts électriques directs et indirects (RTIEBT). Utilisation du système TT: protection contre les chocs électriques requiert la mise en oeuvre de mesures de sécurité.

Contacts directs: isolement des parties actives et code IP égal ou supérieur à IP2X. Dispositifs différentiels à haute sensibilité (I n<30mA).

Contacts indirects: dispositifs différentiels adaptés aux conditions du circuit à protéger (humidité; type d'utilisateurs). Équipotentialisation des masses métalliques simultanément accessibles (cuisines).

Protection de l'installation
Disjoncteurs magnéto-thermiques à l'origine des circuits pour la protection contre des surcharges et des courts-circuits

PT **Quiosques e Esplanadas Protecção de Pessoas**
Protecção contra choques e contactos eléctricos (RTIEBT). Utilização do sistema TT: protecção contra choques eléctricos com medidas de segurança.

Contactos directos: isolamento das partes activas e utilização de IP igual ou superior a IP2X. Diferenciais de alta sensibilidade (In<30mA).

Contactos indirectos: Diferenciais de acordo com o circuito a proteger (humidade; tipo de utilizadores). Equipotencialização das massas metálicas acessíveis em simultâneo (cozinhas).

Protecção da instalação
Disjuntores magneto-térmicos na origem dos circuitos, evitando sobrecarga e eliminando os curto-circuitos.

EN **Public Lighting**
Ensuring the safety of outdoor public spaces (EN 13 201). LED lighting: color rendering index (CRI> 75); color temperature to be defined; average life span 60.000h (highest); low energy consumption.

Photovoltaic systems
Autonomous LED and Photovoltaic technology lighting poles. Such lighting poles produce electricity during the day which is stored in a battery bank and used later in the night period to feed the lamp. Suppress the network energy consumption. Assembly time is avoid, requiring no trenching.

FR **Éclairage public**
Assure la sécurité des espaces publics extérieurs (EN 13201). Utilisation des luminaires LED: indice de restitution chromatique IRC>75; température de couleur à définir; durée de vie moyenne 60.000h (le plus élevé); basse consommation énergétique.

Solutions photovoltaïques
Lampes d'éclairage public autonomes avec la technologie LED et photovoltaïque. Production de l'énergie photovoltaïque pendant la journée entreposée dans un banc de batteries, et utilisée pendant la nuit. Suppression de la consommation d'énergie provenant du réseau électrique. Réduction du temps de montage; ne nécessite pas l'ouverture de tranchées.

PT **Iluminação Pública**
Garantindo segurança no espaço exterior (EN 13201). Utilização de luminárias LED: índice de restituição cromática IRC>75; temperatura da cor a seleccionar; elevado tempo médio de vida útil, 60.000h e baixo consumo energético.

Alimentação Fotovoltaica
Candeieiros de iluminação autónomos com Tecnologia LED e fotovoltaica. Produção de energia fotovoltaica diurna, armazenada em baterias, utilizada no período nocturno. Suprimido o consumo de energia da rede. Evita tempo de montagem, não necessitando abertura de valas.

Rotomolding Rotomoulage Rotomoldagem

EN Thermic transformation process of polymers (above a certain temperature), like polyethylene (PE), polypropylene (PP) or PVC.

The polymers powder is filled into a metallic mould, which is exposed to a biaxial movement and heated to a temperature which can go until 300°C. High temperature enables the fusion of the polymer, while the biaxial movement enables the distribution of the material throughout the mould's surface. The cooling cycle starts (done by pressured air) to harden the polymer and enable a secure demoulding process.

FR Procédé thermique de transformation des polymères (au-dessus d'une certaine température), comme le polyéthylène (PE), polypropylène (PP) ou en PVC. Le matière en poudre est introduit dans un moule métallique et soumis à une rotation bi-axiale à une température jusqu'à 300°C. Haute température permet la fusion du polymère, et le mouvement biaxial permet la distribution des matériaux tout au long de la surface du moule. Après un certain temps, le moule est retiré du four et soigneusement refroidi (par air comprimé), pour durcir le polymère et permettent le processus de moulage sécurisé.

PT Transformação de termoplásticos (polímeros líquidos acima de dada temperatura): polietileno, polipropileno ou PVC. A matéria é colocada em pó no interior do molde metálico, sujeito a uma rotação biaxial a uma temperatura que chega aos 300 °C. A matéria plástica funde enquanto a rotação distribui o polímero por toda a superfície do molde. O período de arrefecimento, normalmente, obtido por recurso a ar forçado pela utilização de ventiladores mantendo a rotação biaxial, permite solidificar a matéria plástica moldada e a retirada da mesma.

RAL colors available (by approximation)
Other colors may be delivered on request

Couleurs Ral disponibles (par approximation)
Autres couleurs sur consultation

Cores RAL disponíveis (por aproximação)
Outras cores sob consulta

RAL 9016  RAL 6017 

RAL 1021  RAL 8025 

RAL 2004  RAL 7040 

RAL 3020  RAL 7046 

RAL 5013  RAL 9005 

RAL 5015  RAL 9004 