



**Alta**  
 bench | banc | banco  
 design **Daciano da Costa**



EN *“The exaggeration, the modular clarity and the predominance of a volumetric and orthogonal expression, was designed as a counterpoint to the elegance of the delicate curved shapes, giving the piece an undeniable contemporaneity.”*  
 Daciano da Costa

FR *“L’exagération, sa clarté modulaire et la prédomination de l’expression volumétrique et orthogonale, a été conçue en contrepoint avec l’élégance des formes curvilignes, délicates, apportant à la pièce une contemporanéité inégalable.”*  
 Daciano da Costa

PT *“O exagero, a sua clareza modular e o predomínio da expressão volumétrica e ortogonal, foi concebido em contraponto com a elegância das formas curvilíneas, delicadas, dotando a peça de inegável contemporaneidade.”*  
 Daciano da Costa

bench with backrest  
banc avec dossier  
banco com costas

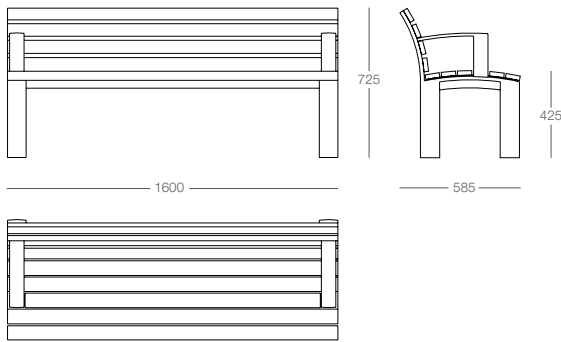

**Standard:**  
Enamel forge Q808  
Kambala + Walnut lasur  
Metallization

Émail forge Q808  
latandza + vernis Noyer  
Métallisation

Esmalte forja Q808  
Kambala + verniz Nogueira  
Metalização



Larus registers  
its products

Larus enregistre  
ses produits

A Larus regista  
os seus produtos  
no INPI

EN **Structure:** cast iron [LFF1]  
**Seat:** kambala or FSC  
Kambala wood [LV1]  
**Fixing:** [LF1]

Refer to technical section  
at the end of the catalog

FR **Structure:** fonte [LFF1]  
**Siège:** bois latandza ou bois FSC  
latandza [LV1]  
**Fixation:** [LF1]

Consulter section technique  
à la fin du catalogue

PT **Estrutura:** ferro fundido [LFF1]  
**Assento:** madeira Kambala ou FSC  
Kambala [LV1]  
**Fixação:** [LF1]

Consultar secção técnica  
no final do catálogo

remarks  
remarques  
notas

pictogram list  
liste des pictogrammes  
legenda de pictogramas

1.  
unless otherwise stated, all standard steel products are metallized;  
sauf indication contraire, tous les produits en acier standard sont métallisés;  
salvo indicação em contrário, todos os produtos standard em aço são metalizados;
2.  
all cast iron parts are metallized, galvanized cast iron is not possible;  
toutes les pièces en fonte sont métallisées, fonte galvanisée n'est pas possible;  
todas as peças em ferro fundido são metalizadas, galvanização de ferro fundido não é possível;
3.  
FSC Kambala wood available upon request;  
Bois FSC latandza possible sur demande;  
madeira FSC Kambala possível mediante orçamentação;



metallized cast iron  
fonte métallisée  
ferro fundido metalizado



glulam  
bois lamellée  
madeira lamelada



cast aluminium  
fonte aluminium  
aluminium fundido



particleboard  
aggloméré de bois  
aglomerado de madeira



rotomolded plastic  
plastique rotomoulé  
plástico rotomoldado



phenolic resin (HPL)  
résine phénolique (HPL)  
resina fenólica (HPL)



steel  
acier  
aço



sandwich panel  
panneau sandwich  
painel sandwich



stainless steel  
acier inoxydable  
aço inoxidável



plastic  
plastique  
plástico



corten steel  
acier corten  
aço corten



perforated shade screen  
tôle perforée  
tela perfurada



aluminium  
aluminium  
aluminium



laminated glass  
verre feuilleté  
vidro laminado



anodized aluminium  
aluminium anodisé  
aluminium anodizado



tempered glass  
verre trempé  
vidro temperado



stone  
pierre  
pedra



frosted tempered glass  
verre givré trempé  
vidro temperado fosco



granite  
granit  
granito



metallization  
métallisation  
metalização



concrete  
béton  
betão



galvanization / zined  
galvanisation / zingué  
galvanização / zincagem



fiberglass  
fibre de verre  
fibra de vidro



painting  
peinture  
pintura



UHPC (ultra high performance concrete)  
UHPC (béton ultra haute performance)  
UHPC (betão ultra-elevado desempenho)



lighting  
éclairage  
iluminação



wood  
bois  
madeira



LED lighting  
éclairage LED  
iluminação LED



marine plywood  
contreplaqué maritime  
contraplacado marítimo



solar panel  
panneau solaire  
painel solar



FSC certified wood  
bois certifié FSC  
madeira certificada FSC



modular  
modulaire  
modular



deck  
deck  
deck

**material references**  
**références des matériaux**  
**referências de materiais**

<b>LAI</b> steel S275JR galvanized and painted acier S275JR galvanisé et peint aço S275JR galvanizado e pintado	<b>LB1</b> concrete C30/37 XC4 béton C30/37 XC4 betão C30/37 XC4	<b>LPS</b> sandwich panel panneau sandwich painel sandwich
<b>LAL2</b> steel S275JR metallized and painted acier S275JR acier métallisée et peint aço S275JR metalizado e pintado	<b>LB2</b> washed concrete béton lavé betão lavado	<b>LR1</b> rotomolded plastic in polyethylene resin plastique rotomoulé avec résine de polyéthylène plástico rotomoldado com resina de polietileno
<b>LAC1</b> corten steel A S 335 J2 G2W acier corten A S 335 J2 G2W aço corten A S 335 J2 G2W	<b>LCM1</b> marine plywood contreplaqué pin maritime contraplacado marítimo	<b>LR2</b> plastic plastique plástico
<b>LAL1</b> extruded and anodized aluminum (C177.006, C117.007 e C117.009) aluminium extrudé et anodisé (C177.006, C117.007 e C117.009) alumínio extrudido e anodizado (C177.006, C117.007 e C117.009)	<b>LCR</b> dupont corian® dupont corian® dupont corian®	<b>LRF1</b> phenolic resin (HPL- high pressure laminates) résine phénolique (HPL - stratifiés haute pression) resina fenólica (HPL- laminado a alta pressão)
<b>LAL2</b> aluminum OL.838059.1 aluminium OL.838059.1 alumínio OL.838059.1	<b>LFV</b> fiberglass fibre de verre fibra de vidro	<b>LT1</b> shade screen ferrari soltis 86® toile ferrari soltis 86® tela ferrari soltis 86®
<b>LAL3</b> cast aluminum fonte d'aluminium alumínio fundido	<b>LG1</b> granite granit granito	<b>LV1</b> water-based lasur/varnish with UV protection lasure/vernis aqueuse avec protection UV lasure/verniz aquoso com proteção UV
<b>LAX1</b> stainless steel AISI 304/316 acier inoxydable AISI 304/316 aço inox AISI 304/316	<b>UHPC</b> ultra high performance concrete béton ultra-haute performance betão de ultra-elevado desempenho	<b>LVL</b> laminated glass verre feuilleté vidro laminado
<b>LAZ1</b> zincated steel acier zingué aço zincado	<b>LLC</b> chrome plated brass laiton chromé latão cromado	<b>LVT</b> tempered glass verre trempé vidro temperado

**fixing system references**  
**références des systèmes de fixation**  
**referências de sistemas de fixação**

<b>LF1</b> rods anchored on the floor/concrete foundation with chemical anchor tiges ancré au sol/fondation en béton avec chevilles chimiques varões chumbados no pavimento/ fundação de betão com bucha química	<b>LF3</b> anchored directly on the concrete foundation ancré directement sur la fondation en béton chumbada diretamente na fundação de betão	<b>LF5</b> foundation on wooden beams previously attached to the structure fondation sur des poutres en bois précédemment fixé à la structure fundação em vigas de madeira previamente fixa à estrutura
<b>LF2</b> anchorage previously attached to the concrete foundation ancré précédemment fixé sur la fondation en béton chumbadouro previamente chumbado na fundação de betão	<b>LF4</b> bolted to the frame previously anchored on the concrete boulonné à la jante précédemment ancré au béton aparafusada ao aro previamente chumbado no betão	<b>LF6</b> floorstanding appuyé sur le sol pousado sobre o solo

Fixing accessories are not included in the price list, being supplied on request, according to local conditions.

Les accessoires de fixation ne sont pas inclus dans la liste de prix, étant fournis sur demande, selon les conditions locales.

Os acessórios de fixação não estão considerados no preço, sendo fornecidos sob consulta, de acordo com as condições locais.

**tolerances for linear dimensions**  
**tolérances pour dimensions linéaires**  
**tolerâncias para dimensões lineares**

dimensions | dimensions | dimensões deviations | déviations | desvios - mm

0 - 100	> 100 - 500	> 500 - 2000	> 2000 - 3000	> 3000 - 5000	> 5000
---------	-------------	--------------	---------------	---------------	--------

tolerances | tolérances | tolerâncias

± 1	± 2	± 3	± 4	± 5	± 10
-----	-----	-----	-----	-----	------

The tolerances in the technical drawings shall prevail over the tolerances in this table.

Les tolérances indiquées dans les dessins techniques doivent prévaloir sur les tolérances indiquées dans ce tableau.

As tolerâncias que constam nos desenhos técnicos prevalecem sobre as tolerâncias desta tabela.

Our products admit dimensional tolerances. For precise dimensions, request for cad-2d drawings.

Nos produits admettent des tolérances dimensionnelles. Pour des dimensions précises, demandez des dessins cad-2d.

Os nossos produtos admitem tolerâncias dimensionais. Para dimensões precisas, solicitar desenhos cad-2d.



**Galvanization  
Galvanisation  
Galvanização**

EN Protection of the surface, obtained by the immersion in a bath of zinc (min 98% of pure zinc) at about 450 °C. The zinc metallurgically reacts with the metal surface of the piece. The thickness of the zinc layer obtained is of at least 60 microns.

**Advantages:**

- The immersion allows to coat hollow pieces.
- The thickness of the coating ensures the protection of edges and corners.

**Disadvantages:**

- The surface may present runoff of the bath.
- Greater difficulty in paint adhesion, requiring sanding or phosphating.
- Not suitable for cast iron. The contents of silicon and phosphorus must be less than 0,04% and 0,02%, being in cast iron always higher than 1% and 0,02%, respectively.

FR Protection de surface, obtenue par immersion dans un bain de zinc (min 98% Zinc pur) à environ 450°C. Le zinc réagit métallurgiquement avec la surface métallique de la pièce, en formant un alliage de zinc/fer. L'épaisseur de la couche de zinc obtenue est, au minimum, de 60 microns.

**Avantages:**

- l'immersion permet de revêtir des pièces creuses.
- L'épaisseur du revêtement assure la protection des bords et des coins.

**Inconvénients:**

- La surface peut présenter un ruissellement du bain de zinc.
- Une plus grande difficulté à adhérence de la peinture, ce qui nécessite un ponçage ou phosphatage.
- Ne convient pas pour la fonte. Les teneurs en silicium et phosphore doivent être inférieures à 0,04% et 0,02%, étant toujours, en fonte, supérieure respectivement à 1% et 0,02%.

PT Protecção de superfície por imersão num banho de zinco (min 98% Zinco) a cerca de 450°C. Reagindo com a superfície metálica forma uma liga de Zinco/Ferro. A espessura de zinco é, no mínimo, de 60 microns.

**Vantagens:**

- A imersão permite revestir peças ocas.
- A espessura do revestimento garante a protecção de arestas e esquinas.

**Inconvenientes:**

- Podem existir escorrimentos do banho.
- Para a adesão da pintura, é necessário lixar a superfície ou usar fosfatação.
- Não adequado ao ferro fundido.

Os teores em silício e fósforo devem ser inferiores a 0,04% e 0,02% sendo, no ferro fundido, sempre superiores a 1% e 0,02%, respetivamente.

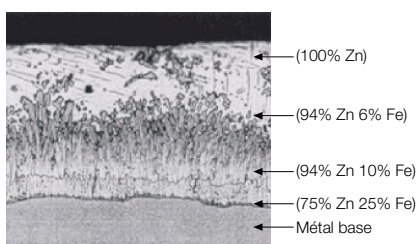

**Wood  
Bois  
Madeira**

EN Wood is one of the most important building materials and requires an energy consumption for its production (5 to 7.5 KWH / Ton) much lower than other materials (concrete 25 to 300; glass 6000, plastic 8200 to 20.000, aluminum 72.000). It is also the only renewable building material and neutral regarding the CO2 emission.

**Inconvenients:**

- In contact with ground water, or soaked, the wood may be attacked by fungi;
- In environments of low oxygen content, the wood may be attacked by bacteria;
- Used outdoors, it is susceptible of having cracks caused by the absorption of water;
- Subject to the action of UV rays, lignin, a component of the wood, rots.

For each use it is necessary to apply the woods with the most recommended features, as well as to employ preserving treatments. After slaughter, the water content (initially above 40%) decreases. Free water evaporates, until reaching the saturation point of the fibers. Here, the remaining water is retained in the cell walls and its content is around 30%.

If the wood dries below the saturation point of the fiber, it shrinks, but it swells again if it is moistened.

- The tangential contraction is about twice the radial contraction;
- The axial (length of the torus) contraction is very low.

The wood should be dried out before use (until the characteristic content moisture of the application area).

FR Le bois est l'un des matériaux de construction les plus importants et qui exige une consommation d'énergie pour sa production (5 à 7,5 KWH/Ton) très inférieure aux autres matériaux (béton 25 à 300; verre 6.000; plastique 8.200 à 20.000; aluminium 72.000).

C'est aussi le seul matériau de construction renouvelable et neutre quant à l'émission de CO2.

**Inconvénients:**

- En contact avec l'eau du sol, ou en immersion, le bois peut être attaqué par des champignons;
- Dans des milieux à basse teneur en oxygène, le bois peut être attaqué par des bactéries;
- Utilisé à l'extérieur, il est susceptible de subir des fentes causées par l'absorption de l'eau;
- Soumis à l'action des rayons UV, la lignine, un des composants du bois, pourrit.

Pour chaque utilisation, il faut employer les bois possédant les caractéristiques conseillées, et faire également appel à des traitements de préservation.

Après abattage, la teneur en eau (initialement supérieure à 40%), diminue. L'eau libre s'évapore, jusqu'à atteindre le point de saturation des fibres. L'eau restante se maintient dans les parois des cellules, en tournant autour de 30%.

Si le bois sèche au-dessous du point de saturation des fibres, il rétrécit, mais gonfle à nouveau s'il est humidifié.

- La rétraction tangentielle correspond à près de deux fois la rétraction radiale;
- La rétraction axiale (longueur du tronc) est très faible.

Il faut sécher le bois avant qu'il soit utilisé, jusqu'à la teneur en humidité caractéristique de l'aire d'application.

PT A madeira é um dos mais importantes materiais de construção e exige menor consumo de energia (5 a 7,5 KWH/Ton) para a sua produção que outros materiais (betão 25 a 300; vidro 200; plástico 8,2 a 20 e alumínio 72).

É o único material de construção renovável e neutro quanto à emissão de CO2.

**Inconvenientes:**

- Em contacto com a água do solo, ou em imersão, a madeira pode ser atacada por fungos;
- Em ambientes de reduzido teor de oxigénio, a madeira pode ser atacada por bactéria;
- No exterior sofre fendas e empenos, causados pela absorção da água;
- Sujeita à acção dos raios UV, a lenhina, um dos componentes, apodrece.

Para cada utilização é necessário empregar as madeiras com as características mais aconselhadas, bem como recorrer a tratamentos de preservação.

Após o abate, o teor em água (inicialmente superior a 40%) diminui. A água livre evapora-se até atingir o ponto de saturação das fibras. A água restante mantém-se nas paredes das células, rondando os 30%. A madeira encolhe se secar abaixo do ponto de saturação das fibras, mas incha novamente se for humedecida.

- A contracção tangencial da madeira é cerca de duas vezes a contracção radial;
- A contracção axial (comprimento) é muito reduzida.

Deve secar-se a madeira antes de ser usada, próximo ao teor de humidade característico da área de aplicação.

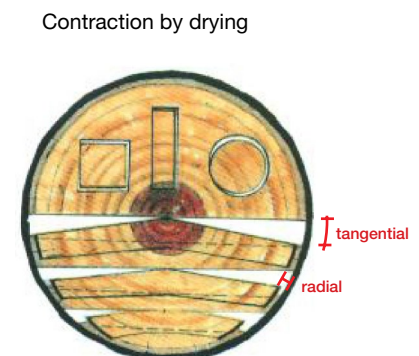
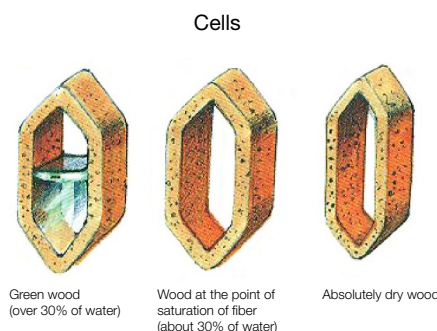

## Cracks and warping in wood Fentes et Gauchissements (bois) Fendas e Empenos na madeira

EN When hitting one side of the timber, the sun and wind remove the surface water. The water in the interior will come to the surface at a speed slower than its removal from the surface. The peripheral layers (more dry) shrink more than the inner layers (more humid), creating internal tensions that are relieved with the opening of cracks that soften when the external humidity increases. In the case of a board, warping is caused by the contraction of the dried layers, contrary to the opposite side, that doesn't contract in the same way and is unable to completely counteract this effort. Therefore the use of wide boards should be avoided.

The wood cracks the most the lower its density is, because there are more empty spaces between the cells occupied by air.

FR Le soleil et le vent, qui ont une incidence sur le bois, en retirent l'eau superficielle. L'eau existante à l'intérieur migre vers la surface, à une vitesse plus lente que celle qui est retirée de la surface. Les couches périphériques, plus sèches, se rétractent davantage que les couches intérieures, en générant des tensions internes qui sont soulagées par l'ouverture de fentes qui, lorsque l'humidité extérieure augmente, s'atténuent à nouveau.

Dans le cas d'une planche, le gauchissement est provoqué par la rétraction des couches sèches, contrairement au côté opposé, qui ne s'est pas rétracté de la même manière et qui n'a pas la capacité de contrarier complètement cet effort. Il faut donc éviter l'utilisation de planches très larges.

Plus petite est leur intensité, plus les bois se fendent, car ils ont plus d'espaces vides entre les cellules occupées par l'air.

PT O sol e o vento, ao incidirem sobre a madeira, removem a água superficial. A água no interior migra para a superfície, a uma velocidade inferior à que é removida. As camadas periféricas, mais secas, retraem-se mais que as camadas interiores, gerando tensões internas, aliviadas com a abertura de fendas que, quando a humidade exterior aumenta, se atenuam novamente. Numa tábuca o empeno é provocado pela contracção das camadas secadas, em oposição à face oposta, que não contraiu nem consegue contrariar este esforço. Deve evitar-se a utilização de tábuas muito largas. As madeiras fendilham tanto mais quanto menor for a sua densidade, pois têm mais espaços vazios entre as células.



## Protective varnish/lasur in wood Vernis/lasure protecteur (bois) Verniz protector na madeira

EN The action of the U.V. rays causes the degradation of lignin, favoring its decay. Varnish possesses iron oxides working as parallel lamellae to timber surface, promoting the reflection of the U.V. rays. The greater the number of varnish applications, the greater the UV protection would be. However, it darkens the color of the wood. Varnish is non-toxic, aqueous solvent, particularly suitable for the use of children. Immersion of a wood filler promotes the adhesion of resin to wood, preceded by a minimum of two varnish coats.

For maintenance, wooden slats must be individually sanded, cleaning the layer that contains decomposed lignin. Apply at least two coats of non-toxic varnish within two-year intervals.

This time period should be reduced with the increasing aggressiveness of the environment. With a greater number of varnish coats, we enlarge the time period between maintenance.

FR Les rayons UV cause la dégradation de la lignine en favorisant son pourrissement. Les vernis possèdent des oxydes de fer qui fonctionnant comme des lamelles parallèles à la surface du bois, favorisent la réflexion des rayons UV. Plus il y aura d'applications de vernis et plus le bois sera protégé contre les UV. Toutefois, la couleur du bois devient plus foncée.

Le vernis est non toxique, à solvant aqueux, adapté à l'utilisation par des enfants. Une substance d'imprégnation favorise l'adhérence de la résine au bois, suivie d'un minimum de 2 couches de vernis.

Pour l'entretien il faut poncer les lattes individuellement, nettoyées de la couche qui contient la lignine décomposée. Appliquer, au minimum, 2 couches de vernis tous les 2 ans.

Il faut réduire ce délai, avec l'augmentation de l'agressivité du milieu. Avec un plus grand nombre de couches de vernis, nous prolongeons la durée entre les entretiens.

PT Os raios U.V. degradam a lenhina, originado o apodrecimento superficial. Os vernizes com óxidos de ferro constituem lamelas paralelas à superfície da madeira, provocando a reflexão dos raios U.V. Excessiva aplicação favorece a protecção aos UV, mas escurece a madeira. O verniz é não tóxico, aquoso, adequado à utilização por crianças. Um impregnante favorece a aderência da resina, antes de 2 demãos de verniz.

Para a manutenção devem lixar-se as réguas individualmente, limpas da camada da lenhina decomposta. Aplicar 2 demãos de verniz de 2 em 2 anos.

Deve reduzir-se este prazo com o aumento da agressividade do ambiente. Com maior número de demãos de verniz, amplia-se o tempo entre manutenções.

## Paint Peinture Pintura

EN **Enamel Forge** - On the primer a metal enamel is applied with high anticorrosive power and weather resistance. It has the appearance of wrought iron.

**Epoxy** - iron oxide paint, with higher durability, hardness and resistance.

**Synthetic Enamel** - Bright, used for the painting of steel structures. Has good gloss retention.

**Polyurethane Enamel** - With high brightness, is used for painting of metal and wooden structures. It has high gloss retention and risk resistance. It has an excellent adhesion to iron and wood and highly resistant in corrosive environments.

**Electrostatic powder coating** - Uniform coating with excellent finishing. Excellent adhesion characteristics, abrasion resistance and chemical resistance. It contains no solvents; doesn't emit volatile organic compounds (VOCs) into the atmosphere.

FR **Émail Forge** - On applique, sur le primaire, un émail métallique, anti-corrosif et résistant aux intempéries. Aspect de fer forgé.

**Épóxi** - peinture d'oxyde de fer, durable, dur et résistant.

**Émail synthétique** - Brillant, destiné à la peinture de structures métalliques. Possède une bonne rétention de brillance.

**Émail de polyuréthane** - Haute brillance, destinée à la peinture de substrats métalliques et de bois. Possède haute rétention de brillance et une résistance aux rayures. Excellente adhérence au fer et au bois. Haute résistance aux milieux corrosifs.

**Électrostatique Poudre** - Revêtement uniforme avec une excellente finition.

Excellentes caractéristiques d'adhésion, de résistance à l'abrasion et une résistance chimique. Ne contient pas de solvants, et n'émet pas de composés organiques volatils (COV) dans l'atmosphère.

PT **Esmalte Forja** - Sobre o primário é aplicado esmalte metálico anticorrosivo e resistente com o aspecto de ferro forjado.

**Épóxi** - tinta com óxido de ferro, durável, dura e resistente.

**Esmalte sintético** - Brilhante, destinado à pintura de estruturas metálicas. Possui boa retenção do brilho.

**Esmalte de poliuretano** - Com alto brilho, destinado à pintura de superfícies metálicas e de madeira. Elevada retenção de brilho e resistência ao risco. Boa aderência ao ferro e à madeira. Boa resistência em ambientes corrosivos.

**Tinta Electrostática a Pó** - Revestimento uniforme com bom acabamento. Boas características de adesão, resistência à abrasão e resistência química. Não contém solventes, não emitindo compostos orgânicos voláteis (COV) para a atmosfera.



**Steel / Stainless Steel**  
**Acier / Acier Inox**  
**Aço / Aço inox**

EN **Steel** (EN10025) is an alloy combining iron and carbon, with a maximum carbon content of approx. 2.1%. With **low carbon content (<0.3%)**, has a high ductility and good characteristics for the mechanical work and welding. **Stainless steel**, contain at least 11% of chromium, ensuring a high resistance against corrosion, forming a thin adhesive film, which protects the material from corrosive attacks in contact with water or moist air (AISI 304). With the appropriate additions of chromium, nickel and molybdenum, it is possible to obtain alloys particularly suited to be used in saline or acidic environments (AISI 316). **Corten steel** forms a stable rust-like appearance and incorporates high levels of copper. The iron oxide and copper resulting from oxidation, form an "aged" layer that prevents the progression of oxidation.

FR L'**acier** (EN10025) est un alliage de fer-carbone, avec une teneur maximale en carbone d'environ 2,1%. À **basse teneur en carbone (<0,3%)**, possède une grande ductilité et de bonnes caractéristiques pour le travail mécanique et la soudure. L'**acier inoxydable**, contiennent au minimum 11% de chrome, garantissant une haute résistance à la corrosion, en formant une fine pellicule adhérente et passive qui protège le matériel des attaques corrosives en contact avec l'eau ou avec l'air humide (AISI 304). Avec les additions appropriées de chrome, de nickel et de molybdène, on réussit des alliages particulièrement adaptés à l'utilisation en milieux salins ou acides (AISI 316). L'**Acier Corten** a une apparence de rouille, stable, et intègre niveaux élevés de cuivre. L'oxyde de fer et de cuivre résultant de l'oxydation, forment un couche "âgée" que empêche la progression de l'oxydation.

PT O **aço** (EN10025) é uma liga de ferro-carbono, com um teor máximo em carbono de 2,1%. Com **teor em carbono <0,3%** possui grande ductilidade e boas características para o trabalho mecânico e soldadura. O **aço inoxidável** contém no mínimo 11% de cromo, garantindo elevada resistência à corrosão, protegendo o material de ataques corrosivos em contacto com a humidade (AISI 304). Com as adequadas adições de cromo, níquel e molibdênio, conseguem-se ligas adaptadas à utilização em meios salinos ou ácidos (AISI 316). O **aço corten** incorpora teores elevados de cobre. O óxido de ferro e cobre decorrente da oxidação, forma uma camada "envelhecida" que impede a progressão da oxidação.

**Corten steel aging process**

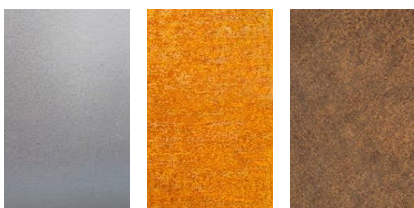

Day 1                      2 Months                      5 Months

**Cast Iron**  
**Fonte**  
**Ferro Fundido**

EN Cast iron is a ferrous alloy with a carbon content higher than 2%. In **lamellar gray cast iron**, graphite solidifies in the form of flakes, result of high levels of carbon and silicon and of slow cooling. This alloy has high capacity for vibration damping, high aptitude for machining, (graphite as lubricant), good corrosion resistance (greater than carbon steel) and a reduced contraction associated with good fluidity that facilitates the casting of complex parts. **Nodular (spheroidal) cast iron** is obtained with the introduction of alloying elements (inoculants) within the liquid bath treatment. The graphite precipitates as nodules or spheres, improving its mechanical properties, which approaches it to steel in ductility and tensile strength.

FR Alliage ferreux avec une teneur en carbone supérieure à 2%. Dans la **fonte grise lamellaire** graphite se solidifie sous la forme de flocons, conséquence des hautes teneurs en carbone et en silice et du refroidissement lentes. Présente une capacité élevée d'amortissement de vibrations, une grande aptitude à l'usinage (graphite comment lubrifiant) , une bonne résistance à la corrosion dans différentes ambiances communes (supérieure aux aciers au carbone) et une faible rétraction, associée à une bonne fluidité, ce qui facilite la fonderie de pièces complexes. La **fonte nodulaire (sphéroïdale)** est obtenue par l'introduction d'éléments inoculants dans le bain liquide. Le graphite est précipité comme nodules ou de sphères, en améliorant les caractéristiques mécaniques, en se rapprochant des aciers en termes de ductilité et de résistance à la traction.

PT Liga ferrosa com teor em carbono superior a 2%. No **ferro fundido lamelar** a grafite solidifica sob a forma de flocos, consequência de altos teores de carbono e silício e de arrefecimento lento. Tem elevada capacidade de amortecimento de vibrações, grande aptidão à maquinagem (grafite como lubrificante), boa resistência à corrosão (superior aos aços ao carbono) e reduzida contracção, associada a uma boa fluidez, facilitando a fundição de peças complexas. O **ferro fundido nodular (esferoidal)** obtém-se pela introdução de inoculantes no banho líquido. A grafite precipita como nódulos ou esferas, melhorando as características mecânicas, aproximando-se dos aços em ductilidade e resistência à tracção.

**lamellar**

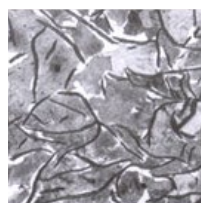

**nodular**

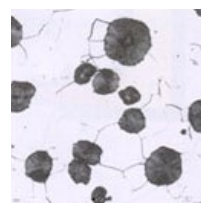

**Metallization**  
**Métallization**  
**Metalização**

EN Protection of a surface, by projecting zinc or a zinc/aluminum alloy, with degreasing and deoxidation through an abrasive jet of shot blasting. The thickness of the zinc layer reached has a minimum thickness of 30-40 microns. **Advantages of painting on metallization:**  
 - It is an ideal surface for subsequent application of painting  
 - Long lasting protection against corrosion, with an excellent abrasion resistance, which limits the frequency and cost of the maintenance, by adjusting the thickness of the coating, depending on the aggressiveness of the environment.  
 - No change of the mechanical properties. **Disadvantages of painting on metallization:**  
 - The interior areas of pieces are not protected.

FR Protection de surface qui consiste en la projection de zinc ou de l'alliage zinc/aluminium, avec dégraissage et désoxydation par un jet abrasif de grenailage. L'épaisseur de la couche de zinc obtenue a un minimum de 30-40 microns. **Avantages de la peinture sur métallisation:**  
 - Constitue une surface idéale pour une application postérieure de peintures  
 - Protection anti-corrosive de longue durée, avec une excellente résistance à l'abrasion, qui limite la fréquence et le coût des entretiens en adaptant l'épaisseur du revêtement en fonction de l'agressivité du milieu.  
 - Aucun changement des propriétés mécaniques. **Inconvénients de la peinture sur métallisation:**  
 - Les aires internes des pièces ne sont pas protégées.

PT Protecção de superfície projectando zinco ou zinco/alumínio, com desoxidação e desgorduramento com jacto abrasivo por granalha, atingindo o depósito de zinco uma espessura mínima de 30-40 microns. **Vantagens da pintura sobre metalização**  
 - A rugosidade da superfície favorece a aderência da pintura.  
 - Protecção anticorrosiva de longa duração, com excelente resistência à abrasão, limitando a manutenção, adaptando a espessura do revestimento em função da agressividade do meio ambiente.  
 - Sem alteração das propriedades mecânicas. **Inconvénients da pintura sobre metalização**  
 - As áreas interiores das peças não são protegidas.

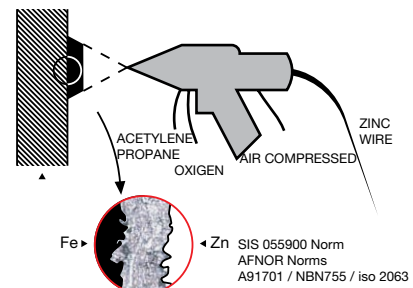



## Electricity Électricité Electricidade

EN **Kiosks and Terraces  
Protection of People**  
Protection against electric shock and electrical contacts is ensured (RTIEBT). Usage of TT system (neutral earthed and earthed mass), for protection against electric shock with the implementation of security measures.  
**Direct contacts:** isolation of the active parts with enclosure IP code equal or superior than IP2X. In addition, high sensitivity differential devices are installed ( $I_n < 30\text{mA}$ ).  
**Indirect contacts:** differentials are used according to the circuit to be protected conditions (humidity, type of users). Equalization of metal mass powers accessible simultaneously is assured (kitchens).  
**Facility Security**  
Protection against overloads and short circuits is assured through the installation of Thermal-Magnetic Breakers at the origin of the circuits.

FR **Kiosques et Terrasses  
Protection des personnes**  
Protection contre les chocs et les contacts électriques directs et indirects (RTIEBT). Utilisation du système TT: protection contre les chocs électriques requiert la mise en oeuvre de mesures de sécurité.  
**Contacts directs:** isolement des parties actives et code IP égal ou supérieur à IP2X. Dispositifs différentiels à haute sensibilité ( $I_n < 30\text{mA}$ ).  
**Contacts indirects:** dispositifs différentiels adaptés aux conditions du circuit à protéger (humidité; type d'utilisateurs). Équipotentialisation des masses métalliques simultanément accessibles (cuisines).  
**Protection de l'installation**  
Disjoncteurs magnéto-thermiques à l'origine des circuits pour la protection contre des surcharges et des courts-circuits

PT **Quiosques e Esplanadas  
Protecção de Pessoas**  
Protecção contra choques e contactos eléctricos (RTIEBT). Utilização do sistema TT: protecção contra choques eléctricos com medidas de segurança.  
**Contactos directos:** isolamento das partes activas e utilização de IP igual ou superior a IP2X. Diferenciais de alta sensibilidade ( $I_n < 30\text{mA}$ ).  
**Contactos indirectos:** Diferenciais de acordo com o circuito a proteger (humidade; tipo de utilizadores). Equipotencialização das massas metálicas acessíveis em simultâneo (cozinhas).  
**Protecção da instalação**  
Disjuntores magneto-térmicos na origem dos circuitos, evitando sobrecarga e eliminando os curto-circuitos.

EN **Public Lighting**  
Ensuring the safety of outdoor public spaces (EN 13 201). LED lighting: color rendering index (CRI) > 75; color temperature to be defined; average life span 60.000h (highest); low energy consumption.

### Photovoltaic systems

Autonomous LED and Photovoltaic technology lighting poles  
Such lighting poles produce electricity during the day which is stored in a battery bank and used later in the night period to feed the lamp.  
Suppress the network energy consumption. Assembly time is avoid, requiring no trenching.

### FR Éclairage public

Assure la sécurité des espaces publics extérieurs (EN 13201). Utilisation des luminaires LED: indice de restitution chromatique IRC > 75; température de couleur à définir; durée de vie moyenne 60.000h (le plus élevé); basse consommation énergétique.

### Solutions photovoltaïques

Lampes d'éclairage public autonomes avec la technologie LED et photovoltaïque. Production de l'énergie photovoltaïque pendant la journée entreposée dans un banc de batteries, et utilisée pendant la nuit. Suppression de la consommation d'énergie provenant du réseau électrique. Réduction du temps de montage; ne nécessite pas l'ouverture de tranchées.

### PT Iluminação Pública

Garantindo segurança no espaço exterior (EN 13201). Utilização de luminárias LED: índice de restituição cromática IRC > 75; temperatura da cor a seleccionar; elevado tempo médio de vida útil, 60.000h e baixo consumo energético.

### Alimentação Fotovoltaica

Candeeiros de iluminação autónomos com Tecnologia LED e fotovoltaica. Produção de energia fotovoltaica diurna, armazenada em baterias, utilizada no período nocturno. Suprimido o consumo de energia da rede. Evita tempo de montagem, não necessitando abertura de valas.

## Rotomolding Rotomoulage Rotomoldagem

EN Thermic transformation process of polymers (above a certain temperature), like polyethylene (PE), polypropylene (PP) or PVC. The polymers powder is filled into a metallic mould, which is exposed to a biaxial movement and heated to a temperature which can go until 300°C.  
High temperature enables the fusion of the polymer, while the biaxial movement enables the distribution of the material throughout the mould's surface.  
The cooling cycle starts (done by pressured air) to harden the polymer and enable a secure demoulding process.











FR Procédé thermique de transformation des polymères (au-dessus d'une certaine température), comme le polyéthylène (PE), polypropylène (PP) ou en PVC. Le matière en poudre est introduit dans un moule métallique et soumis à une rotation bi-axiale à une température jusqu'à 300 ° C. Haute température permet la fusion du polymère, et le mouvement biaxial permet la distribution des matériaux tout au long de la surface du moule. Après un certain temps, le moule est retiré du four et soigneusement refroidi (par air comprimé), pour durcir le polymère et permettent le processus de moulage sécurisé.

PT Transformação de termoplásticos (polímeros líquidos acima de dada temperatura): polietileno, polipropileno ou o PVC. A matéria é colocada em pó no interior do molde metálico sujeito a uma rotação biaxial a uma temperatura que chega aos 300 °C. A matéria plástica funde enquanto a rotação distribuiu o polímero por toda a superfície do molde. O período de arrefecimento, normalmente, obtido por recurso a ar forçado pela utilização de ventiladores, mantendo a rotação biaxial, permite solidificar a matéria plástica moldada e a retirada da mesma.

RAL colors available (by approximation)  
Other colors may be delivered on request

Couleurs Ral disponibles (par approximation)  
Autres couleurs sur consultation

Cores RAL disponíveis (por aproximação)  
Outras cores sob consulta

RAL 9003		RAL 6017	
RAL 1021		RAL 8025	
RAL 2004		RAL 7040	
RAL 3020		RAL 7046	
RAL 5013		RAL 9005	
RAL 5015		RAL 9004	